

1/2"

Max. 60 l/min



Stainless steel
(VA)



Ready for
Future

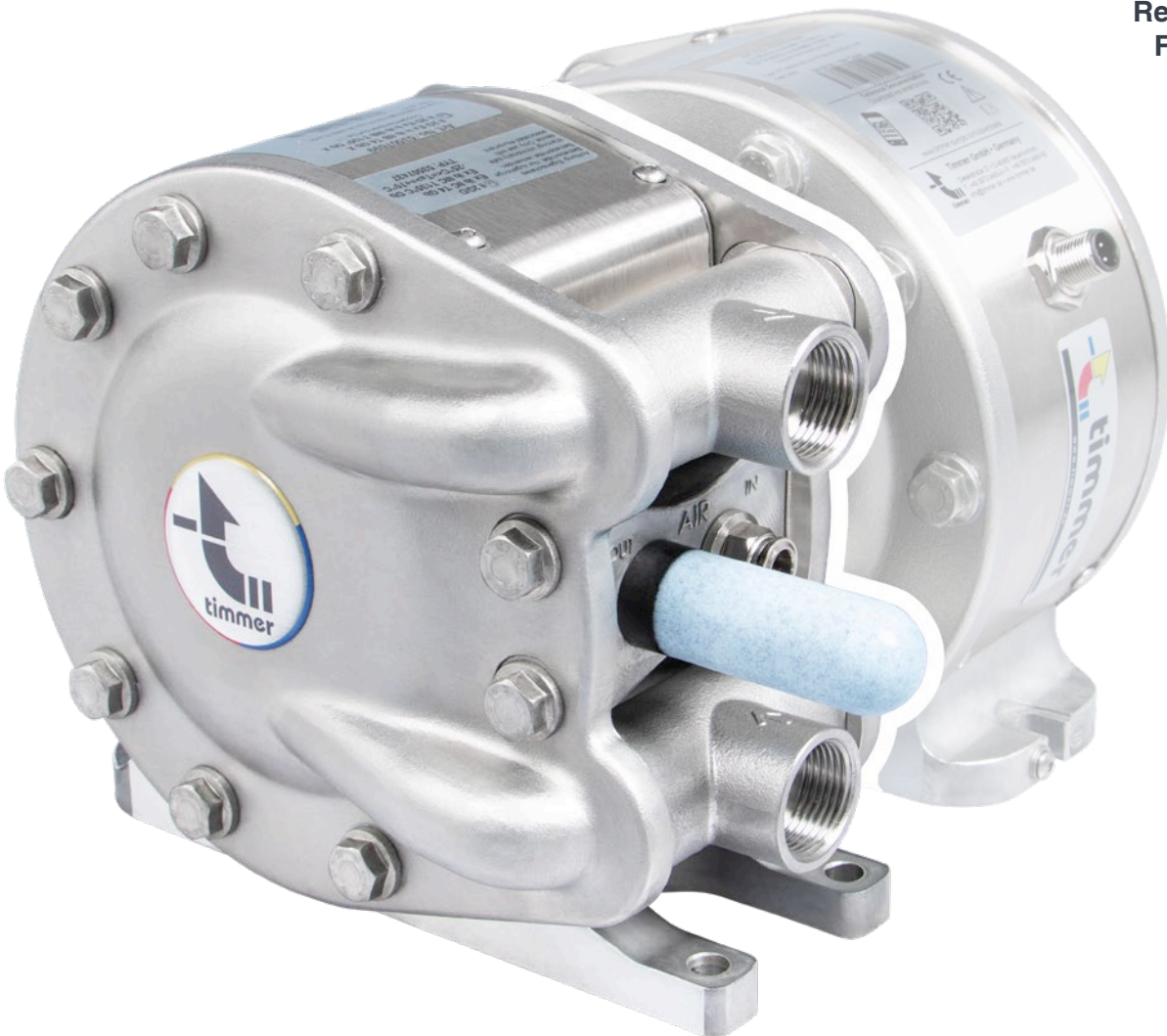

www.timmer-pumps.com/en/double_diaphragm_pumps_1to1/



Integrated intelligent sensor (iHZ)

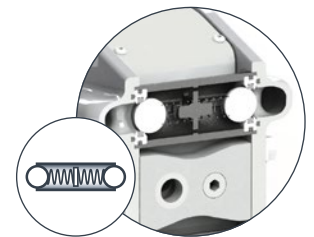

Spring-loaded valve balls

Optional

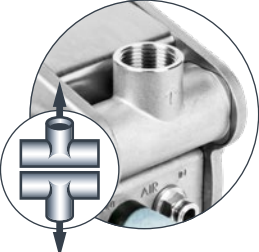

INLINE version
MEM1060I and
MEM1060VI

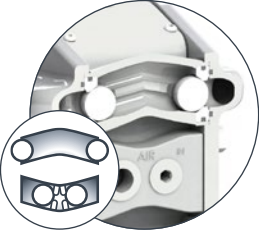

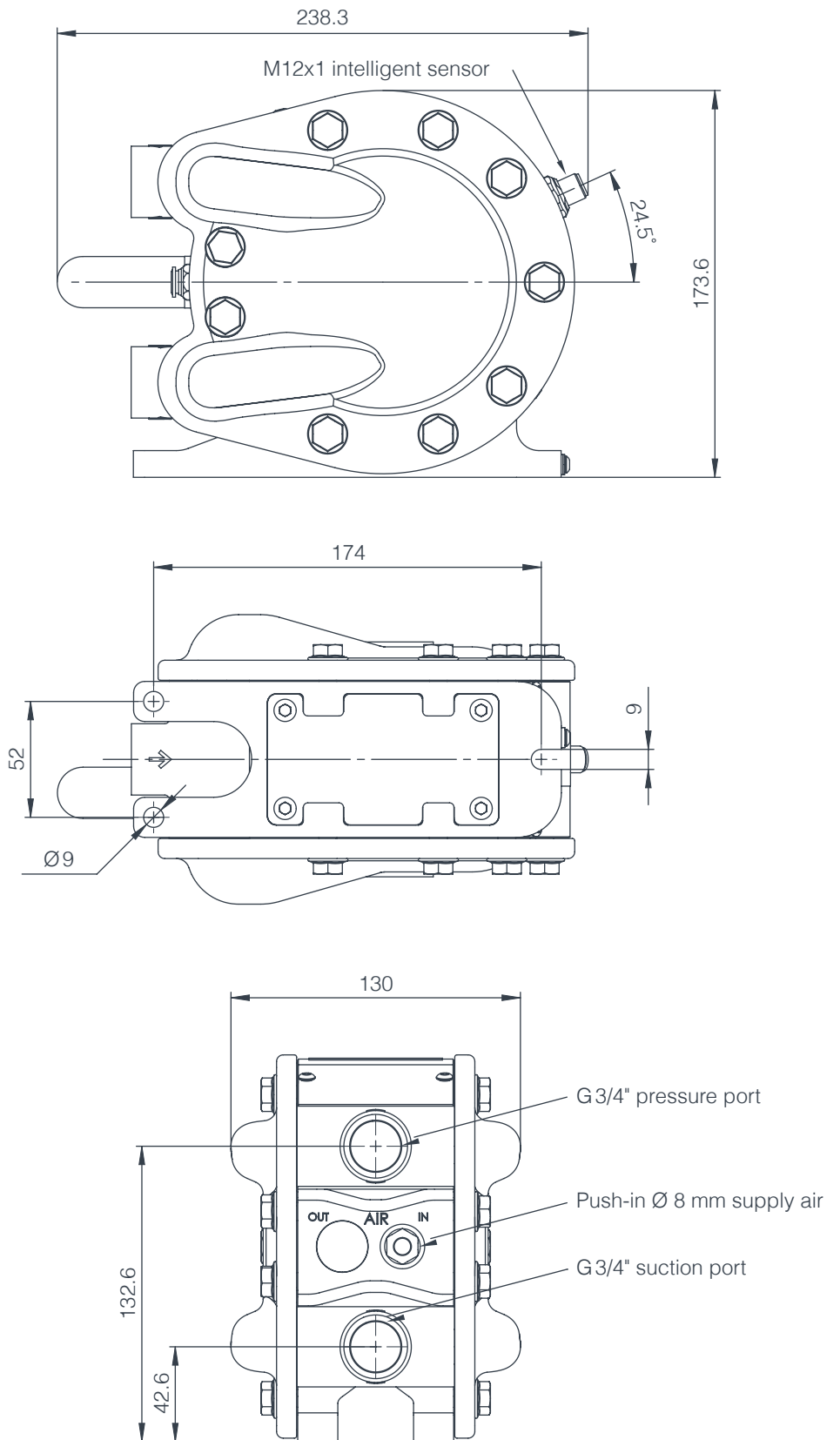

Gravity-loaded valve
balls

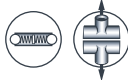

Technical drawing:
All dimensions in mm

PREMIUM double diaphragm pumps PTI-MEM1060-VA

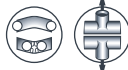
Order no.	Type	Alignment of suction pipe	Alignment of pressure pipe	Material design	ATEX
53507699	PTI-MEM1060-VA-TF-VA-VA-VIEX-AL-iHZ 	Forward	Forward	VA	✓
53507756	PTI-MEM1060I-VA-TF-VA-VA-VIEX-AL-iHZ 	Downward	Upward	VA	✓
53507812	PTI-MEM1060V-VA-TF-TF-VA-VIEX-AL-iHZ 	Forward	Forward	VA	✓
53507834	PTI-MEM1060VI-VA-TF-TF-VA-VIEX-AL-iHZ 	Downward	Upward	VA	✓

The tim[®]PRO series pumps have been successfully used for many years as process pumps and transfer pumps in the paint supply sector and in the printing machine industry.

They are characterized in particular by their process reliability, easy maintenance, small and compact design, good

workmanship and long service life.

These variants are delivered with an intelligent IoT-enabled sensor, which allows real-time testing of the stroke signals via a customer PLC. With connection of our tim[®]IOT smartbox we enable many useful new features increase profitability, process reliability and facilitate preven-

tive maintenance. Simply integrate our tim[®]IOT smartbox in your system and benefit from these advantages. All information in this regard is provided starting on page 84.

Technical data

Transmission ratio	: 1 to 1
Output (max.)	: Approx. 60 l/min (for water) With PTFE composite diaphragm
Drive	: Pneumatic
Fluid connections	: 3/4" internal thread rotates 90°
Operating pressure	: 1 to 8 bar compressed air, unoiled, filtered, oiled
Compressed air connection	: Plug, external hose Ø 8 mm
Suction head, dry	: Max. 4 m
Weight	: Approx. 6.2 kg
Viscosity of pumped medium	: Up to 15,000 mPas
Medium temperature	: Max. +65 °C
Noise level	: 68 dB(A)
Strokes	: Max. 8 double strokes/s
Ex protection	: ATEX (see operating manual for additional information)

Media

The pump is suitable for pumping a wide variety of fluids (media). Resistance to the media that will be pumped must be checked on a case-by-case basis.

We would be happy to advise you on the suitability for your specific application.

Material

Side section	: Stainless steel
Middle housing section	: Aluminium
Fluid seals	: FEPM
Pneumatic seals	: NBR
Valve seats	: Stainless steel
Valve balls	: Stainless steel
Diaphragm	: PTFE / NBR as composite material
Control valves	: Ceramic valve plate / POM
Screws	: Stainless steel
Cover plate	: Stainless steel
Valve pipes	: Stainless steel
Springs	: Spring steel



Fluid delivery volume

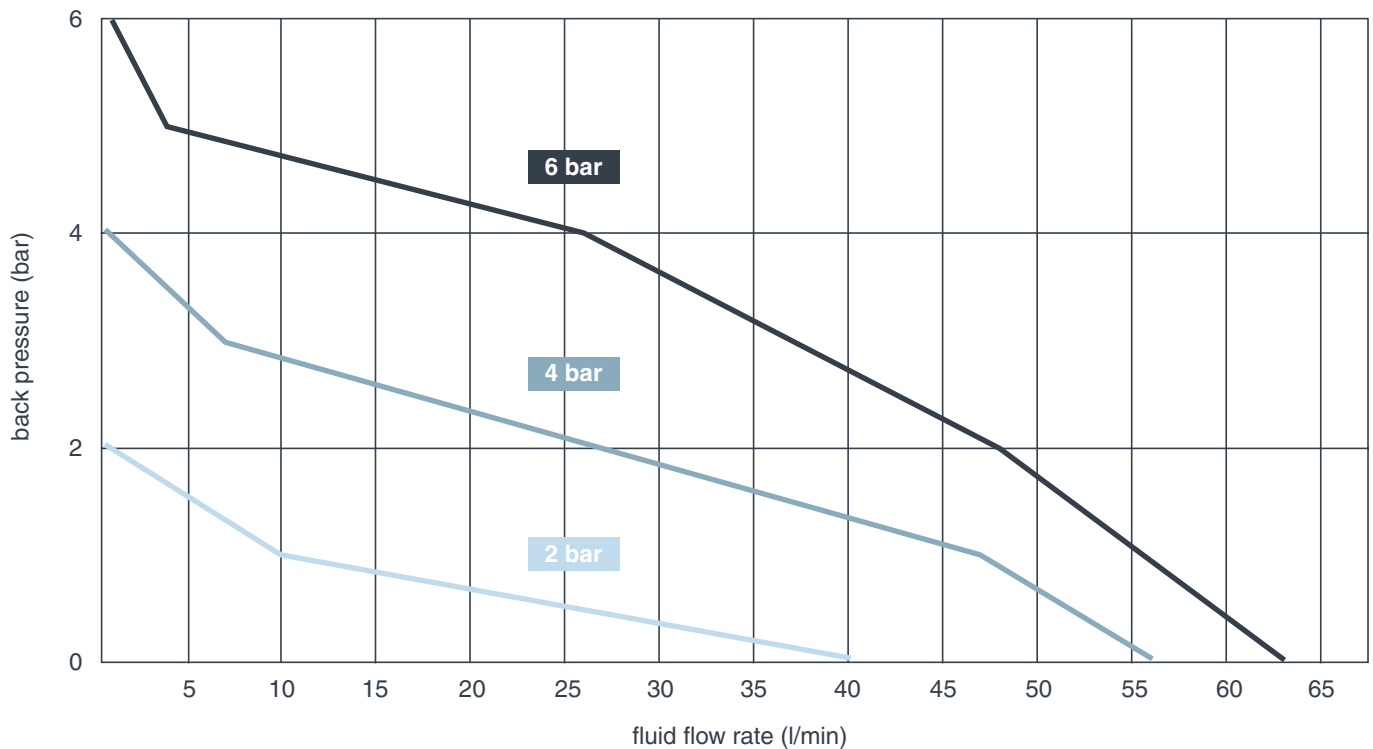

Added values



Minimum pulsation

Minimal changeover times in conjunction with the short-stroke principle of the pumps reduce pulsation to a minimum and ensure a more uniform media flow.



Maximisation of service life

The ceramic slide valve that is used works virtually free of wear. The short-stroke principle prevents over-extension of the diaphragm and thus enables a long service life.



Increased process reliability

Safe start-up of the pump is ensured, even in critical operating situations. The bistable, over-centre valve prevents problematic intermediate positions of the control valve.



Reduced compressed air costs

Optimised geometries with minimal dead spaces, as well as the extremely low start-up pressures, starting at 0.7 bar, reduce energy consumption to a minimum.



Easy conversion in existing systems

Small, compact design thanks to optimised valve technology



Minimal maintenance costs

The durable short-stroke diaphragms, the low-wear ceramic slide valve and the maintenance-friendly structure of the pump guarantee extremely low service costs.