

IEC 60309 Type Industrial Plugs & Sockets Short Form Catalogue

www.mete-enerji.com.tr





MARBLE AND NATURAL STONE INDUSTRY



MARINAS



IRON - STEEL PRODUCTION / PROCESSING



FACTORIES



SHIPYARDS AND SHIP BUILDING PLATFORMS



MACHINERY MANUFACTURING



SOUND, LIGHT AND VISUAL SYSTEMS



AIRPORTS



PANEL APPLICATIONS



GENERATOR PRODUCTION



TRANSPORTATION



CARAVANS

IEC 60309 NORM PLUGS & SOCKETS - "h" value

The position of the earthing contacts is called the h clock system

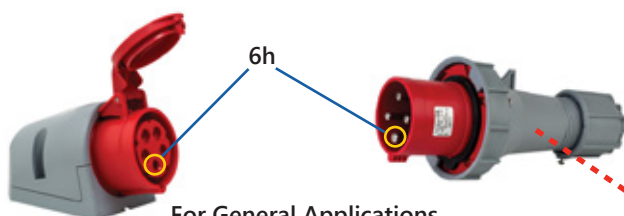

For General Applications (Panel Machine / Sound / Light / Marble Quarry Etc.)

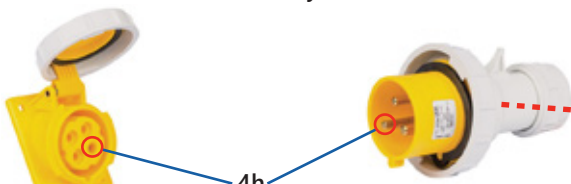

Used For 110V Applications

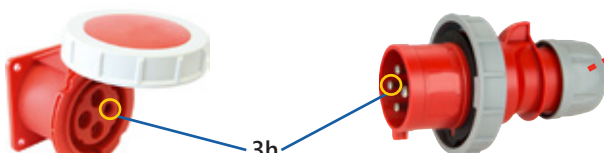

Used For Refrigerated Container Applications

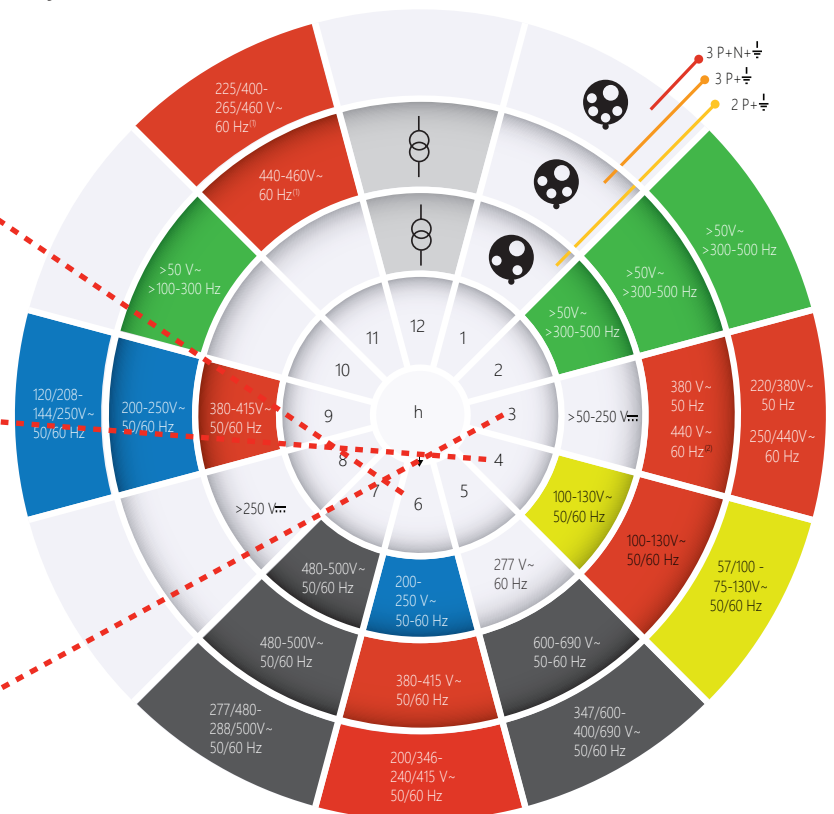

Specs.	CEE Norm Products										
Series	3x16A	4x16A	5x16A	3x32A	4x32A	5x32A	3x63A	4x63A	5x63A	4x125A	5x125A
Ampere	16A	16A	16A	32A	32A	32A	63A	63A	63A	125A	125A
Voltage	200-250V	380-415V	380-415V	200-250V	380-415V	380-415V	200-250V	380-415V	380-415V	380-415V	380-415V
Earthing Position	6h	6h	6h	6h	6h	6h	6h	6h	6h	6h	6h
Number of Poles	2P+E	3P+E	3P+N+E	2P+E	3P+E	3P+N+E	2P+E	3P+E	3P+N+E	3P+E	3P+N+E
Termination	Screw/Quick	Screw/Quick	Screw/Quick	Screw/Quick	Screw/Quick	Screw/Quick	Screw	Screw	Screw	Screw	Screw
Colour	Blue	Red	Red	Blue	Red	Red	Blue	Red	Red	Red	Red
IP Rating	IP44 IP67	IP44 IP67	IP44 IP67	IP44 IP67	IP44 IP67	IP44 IP67	IP44 IP67	IP44 IP67	IP44 IP67	IP67	IP67



Note: 63-125A products are provided only with screw connection option.

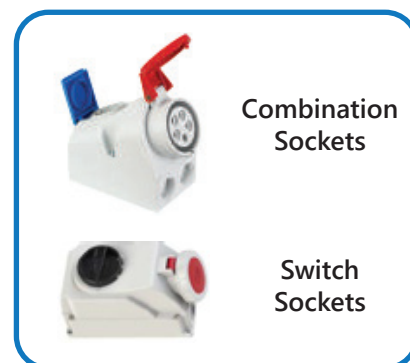
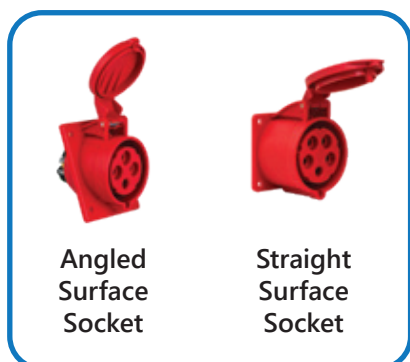

2P
 16/32A
 IP44/67
 20~25V
 IK10
 Screw Connection

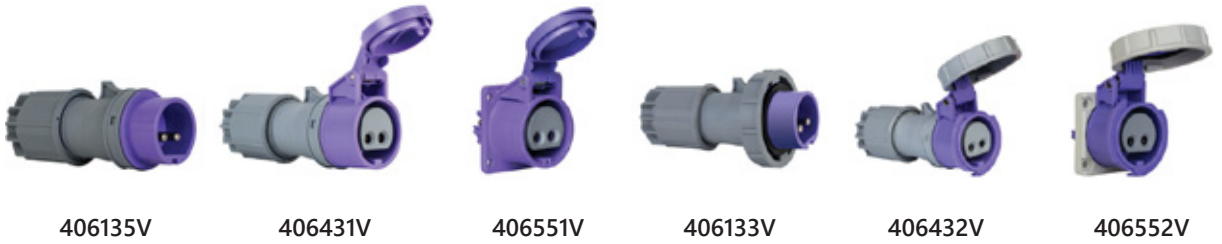

406135V 406431V 406551V 406133V 406432V 406552V

2P+E
 16/32A
 IP44/67
 20~25V
 IK10
 Screw Connection



406134V 406433V 406553V 406138V 406429V 406549V

2P+E
 16/32A
 IP44/67
 100~130V
 IK10
 4h
 Screw Connection



406121V 406425V 406121V 406627V 406122V 406422V 406542V

3P+E
 16/32A
 IP44/67
 100~130V
 IK10
 4h
 Screw Connection



406123V 406423V 406543V 406128V 406428V 406548V

2P+E
 16A
 IP44/67
 200~250V
 IK10
 6h
 Screw Connection



406701V



406702V

Phase Inverter

3P+N+E
 16/32A
 IP44/67
 380~415V
 IK10
 6h
 Quick Connection
 Screw Connection



406160V



406150V

2P+E
16/32A
IP44/67
200~250V
IK10
6h
Quick Connection
Screw Connection



3P+E
16/32A
IP44/67
380~415V
IK10
6h
Quick Connection
Screw Connection



3P+N+E
16/32A
IP44/67
380~415V
IK10
6h
Quick Connection
Screw Connection



"V" AT THE END OF THE CODES REFERS TO THE SCREW CONNECTION

2P+E
 63A
 IP44/67
 200~250V
 IK10
 6h
 Pilot Contact
 Screw Connection



3P+E
 63A
 IP44/67
 380~415V
 IK10
 6h
 Pilot Contact
 Screw Connection



3P+N+E
 63A
 IP44/67
 380~415V
 IK10
 6h
 Pilot Contact
 Screw Connection





One contact
for extreme
environments

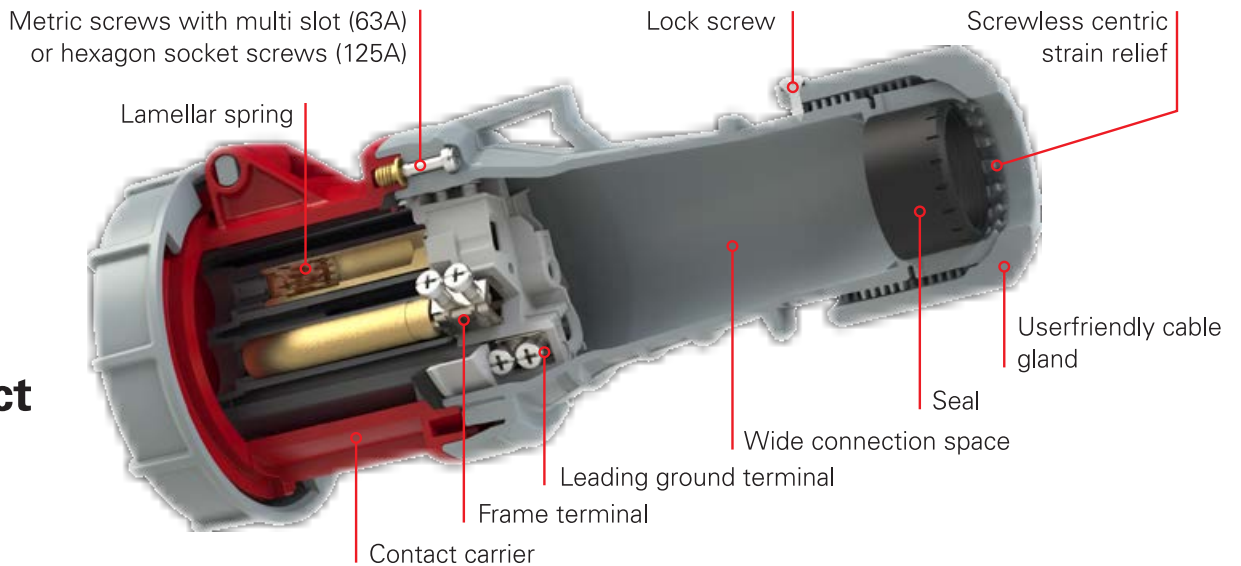



10007 Sokak No:34 A.O.S.B. 35620 Cigli - Izmir / TÜRKİYE

Tel: +90 (232) 376 86 86 + 90 (232) 376 86 49

info@mete-enerji.com.tr

www.mete-enerji.com.tr

